

2836424 - crossbar support ST83-42

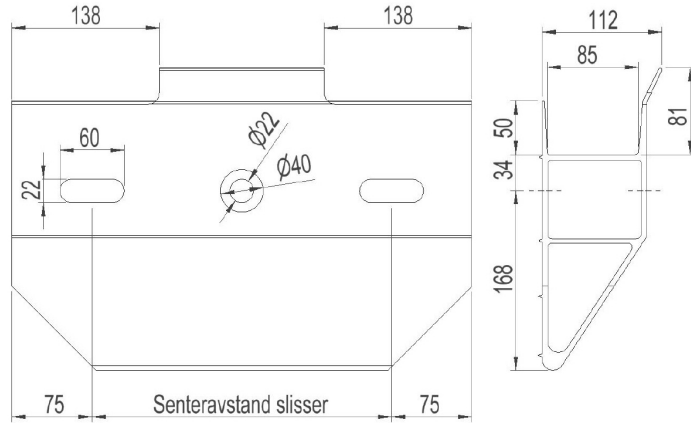
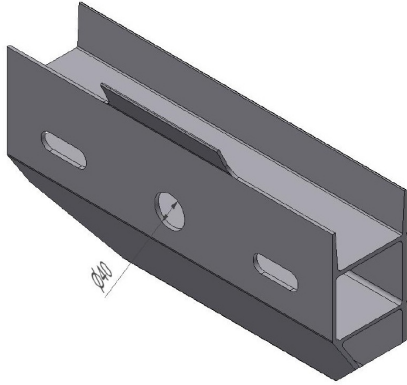

Elnummer	Type	Senteravstand slisser
2836739	ST83S	280mm
2836406	ST83-34	340mm
2836424	ST83-42	420mm

Description	Support for crossbar width 83mm. Oblong hole distance 420mm.
Unit	PSC
Weight	5,12 kg
Material	Aluminium, anodised-brown
Pole fastening	Bolt, 420mm-single pole clamp