

2836427 - Støtte ST160-42

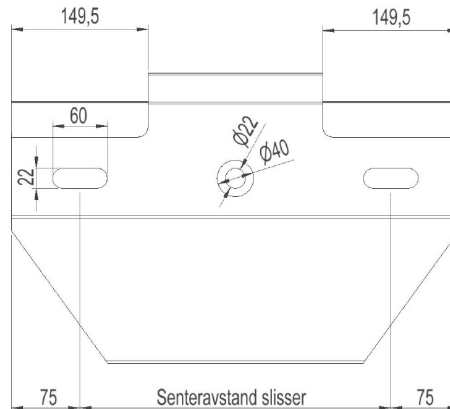
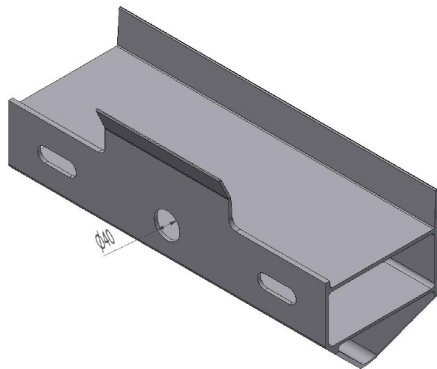

Elnummer	Type	Senteravstand slisser
2836732	ST160S	280mm
2836407	ST160-34	340mm
2836427	ST160-42	420mm
2836428	ST160-50	500mm
2836494	ST160-58	580mm

Beskrivelse	Støtte for travers-bredde 160mm. Slissavstand 420mm. Skal alltid benyttes for traversprofil 7 (160x230).
Enhet	STK
Vekt	6,699 kg
Materiale	Aluminium, bruneloksert
Stolpeinnfesting	Bolt, 420mm-enkel masteklave