

2836428 - Crossbar support ST160-50

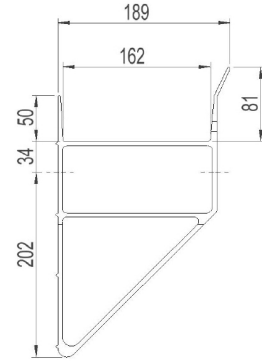
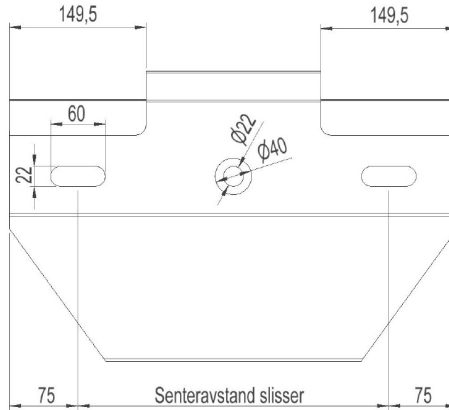
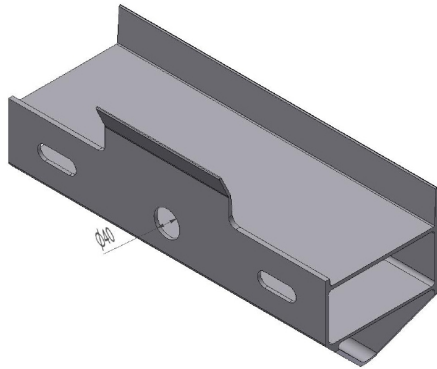

EInummer	Type	Senteravstand slisser
2836732	ST160S	280mm
2836407	ST160-34	340mm
2836427	ST160-42	420mm
2836428	ST160-50	500mm
2836494	ST160-58	580mm

Description	Support for crossbar width 160mm. Oblong hole distance 500mm. Always to be used with crossbar profile 7 (160x230).
Unit	PSC
Weight	7,763 kg
Material	Aluminium, anodised-brown
Pole fastening	Bolt, 500mm-single pole clamp