

2836448 - Counter nut PAL-M20 VF DIN7967

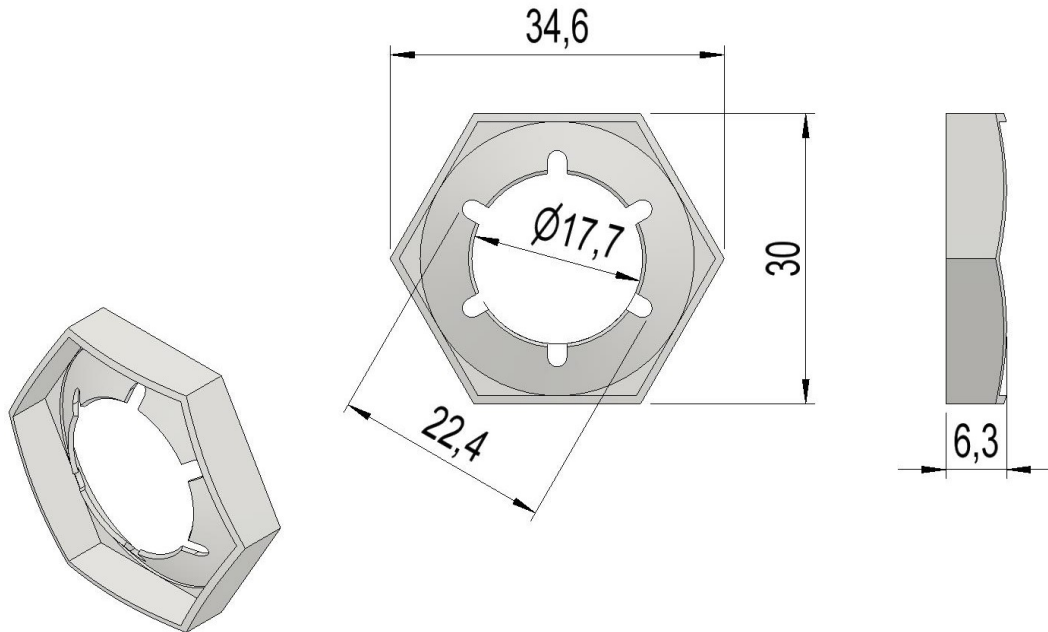

Description	Self locking counter nut to secure nuts. These are made of spring-like steel and is a better alternative than using regular nuts as counter nut.
Unit	PSC
Weight	0,08 kg
Material	Steel galvanised