

## 2836461 - Anch. crossbar TA5050D-58-8S

Cross arm type	H/A-pole
Pole distance	5m
Phase distance	5m
Pole fastening	580mm-double pole clamp

### Crossbar profile P8 (laying)

Weight: (kg/m)	16.982
Cross section: (mm <sup>2</sup> )	6290
Material:	Extruded aluminum, brown anodized
Alloy:	AlMgSi 6082-T6
Moment of resistance: (mm <sup>3</sup> )	W <sub>x</sub> = 272 777 W <sub>y</sub> = 265 967
Area moment of inertia: (mm <sup>4</sup> )	I <sub>x</sub> = 22 101 736 I <sub>y</sub> = 21 543 364
Center distance for I <sub>x</sub> : (mm)	C <sub>x</sub> = 81,03
Center distance for I <sub>y</sub> : (mm)	C <sub>y</sub> = 81,00
Minimum yield strength 0,2: (N/mm <sup>2</sup> )	250
Minimum breaking load: (N/mm <sup>2</sup> )	290

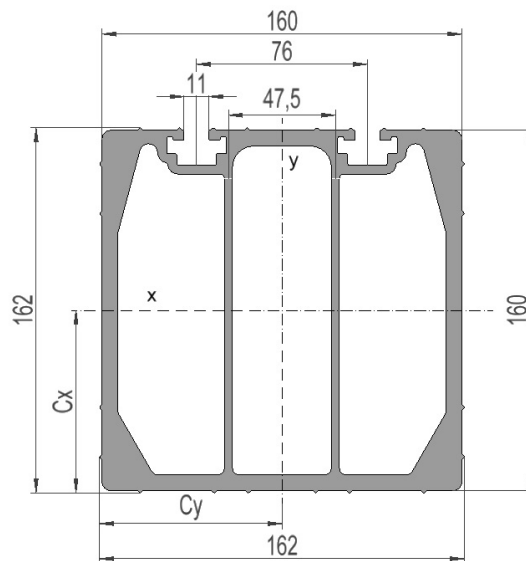

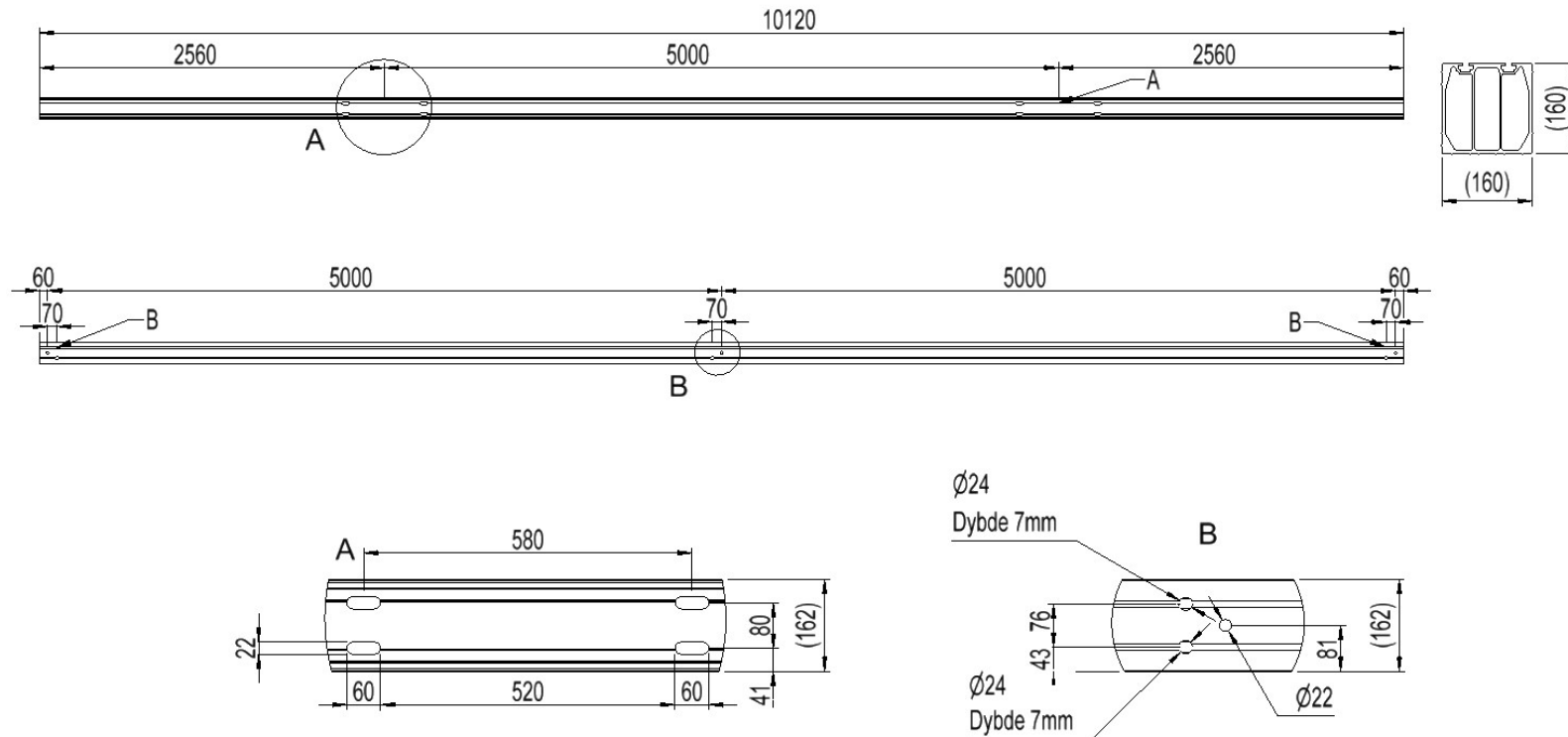

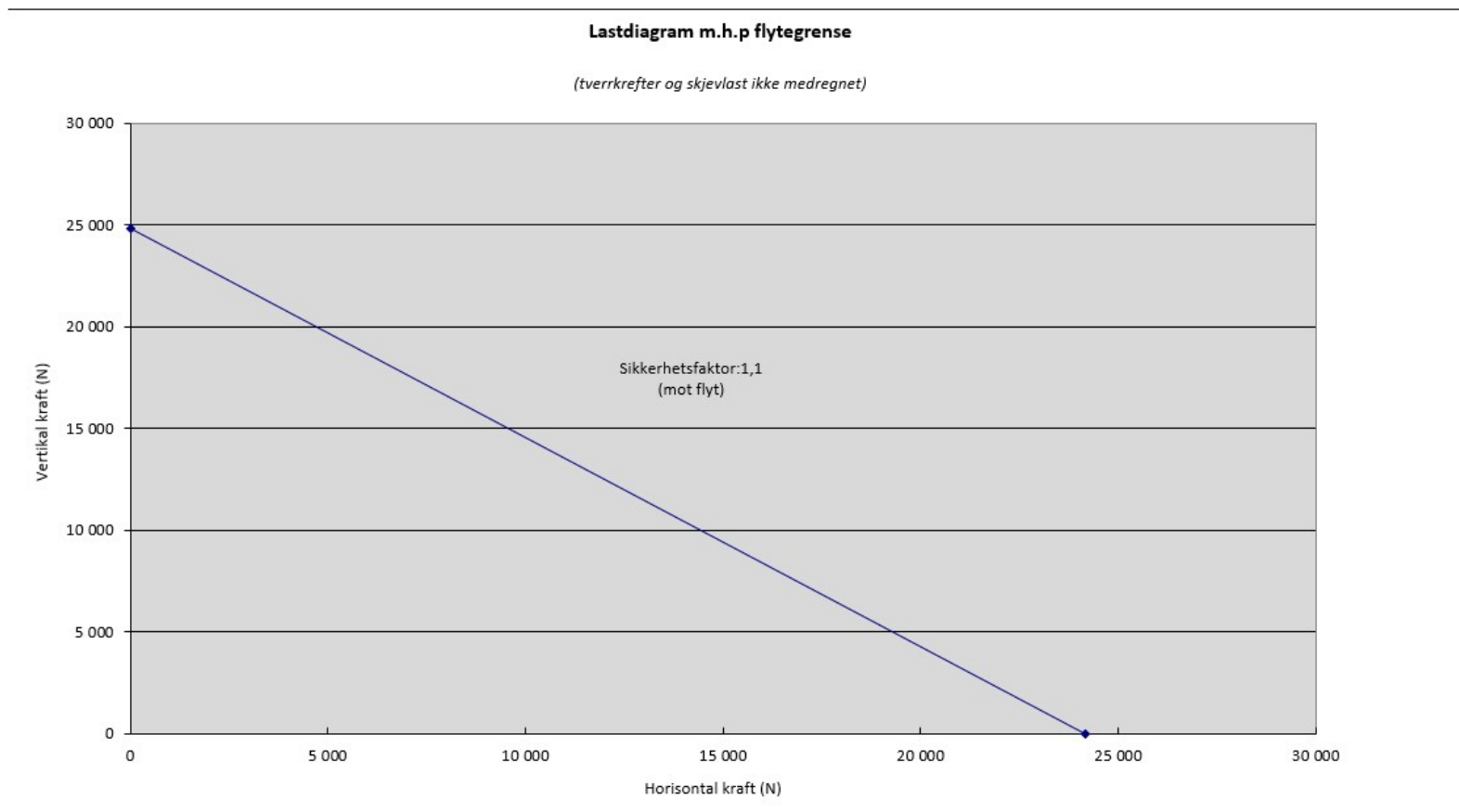

Total bøyning travers i forhold til last

