

2836484 - Phase/wire bracket FFE200

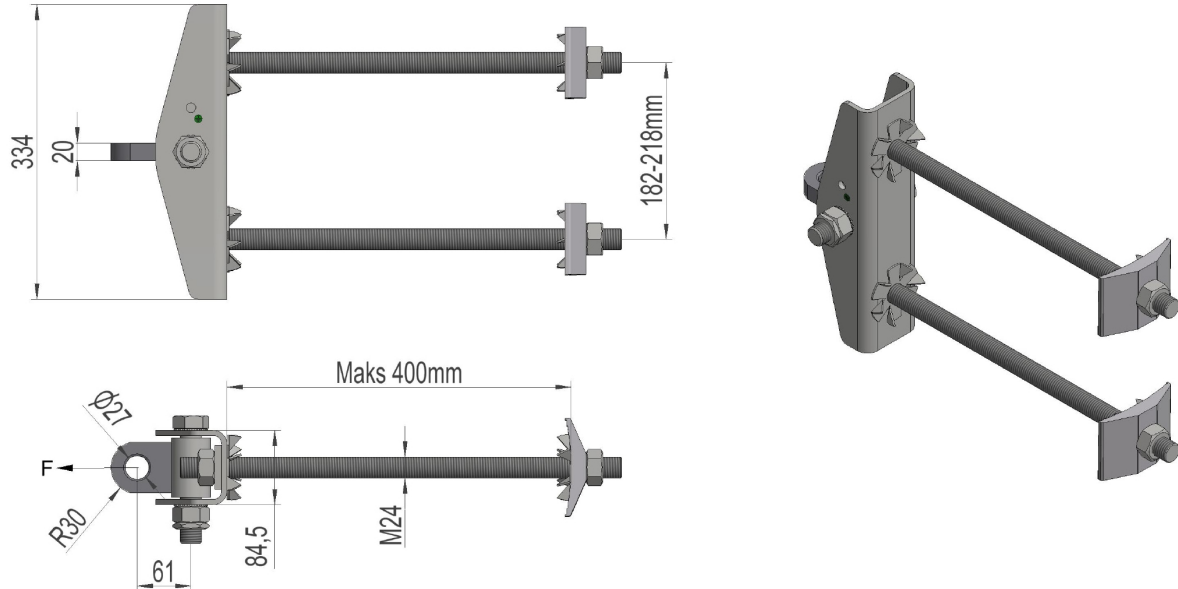

Description	Phase/wire bracket one-sided. With bolts M24 and bolt distance 182-218mm.
Unit	PSC
Weight	10 kg
Material	Steel galvanised
Breaking load (static)	200kN
Hardness	Flag; 170HB