

2836673 - Anch. crossbar TA5050D-50-8S

Cross arm type	H/A-pole
Pole distance	5m
Phase distance	5m
Pole fastening	500mm-double pole clamp

Crossbar profile P8 (laying)

Weight: (kg/m)	16.982
Cross section: (mm ²)	6290
Material:	Extruded aluminum, brown anodized
Alloy:	AlMgSi 6082-T6
Moment of resistance: (mm ³)	W _x = 272 777 W _y = 265 967
Area moment of inertia: (mm ⁴)	I _x = 22 101 736 I _y = 21 543 364
Center distance for I _x : (mm)	C _x = 81,03
Center distance for I _y : (mm)	C _y = 81,00
Minimum yield strength 0,2: (N/mm ²)	250
Minimum breaking load: (N/mm ²)	290

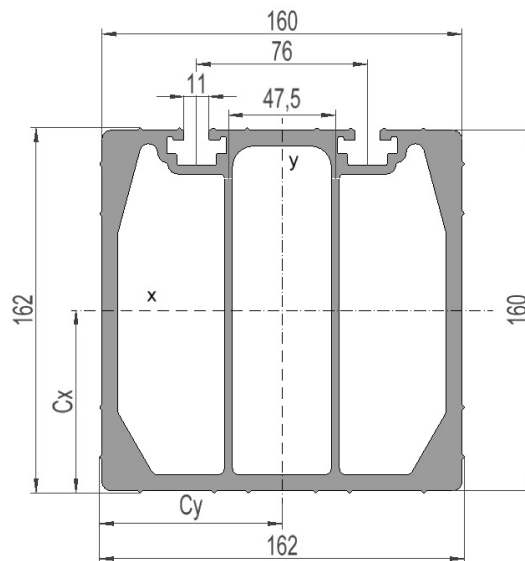

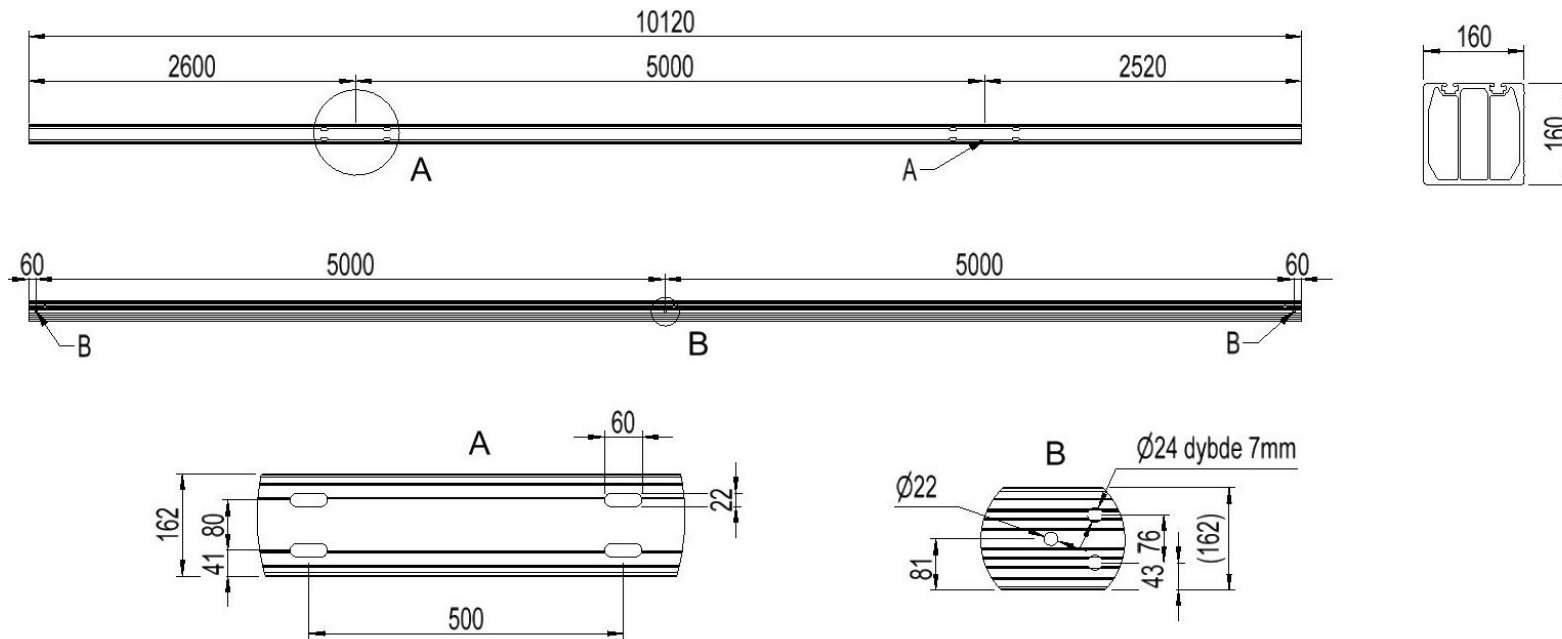

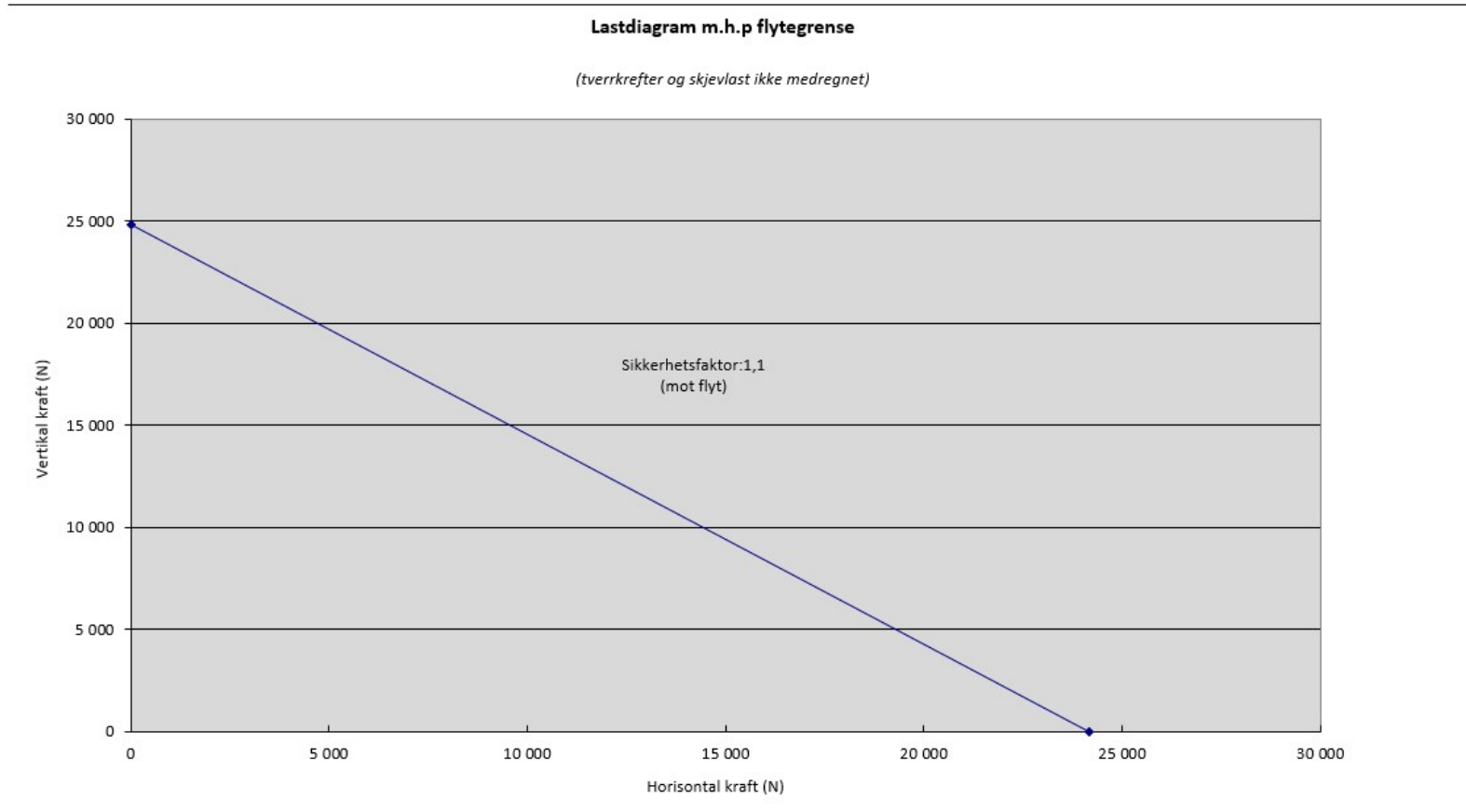

Total bøyning travers i forhold til last

