

2836674 - Anch. crossbar TAS5050D-50-7S

Cross arm type	H/A-pole
Pole distance	5m
Phase distance	5m
Pole fastening	500mm-double pole clamp

Crossbar profile P7 (standing)

Weight: (kg/m)	22.225
Cross section: (mm ²)	8243
Material:	Extruded aluminum, brown anodized
Alloy:	AlMgSi 6082-T6
Moment of resistance: (mm ³)	W _x = 550 278 W _y = 345 747
Area moment of inertia: (mm ⁴)	I _x = 67 111 384 I _y = 28 524 112
Center distance for I _x : (mm)	C _x = 121,96
Center distance for I _y : (mm)	C _y = 82,50
Minimum yield strength 0,2: (N/mm ²)	250
Minimum breaking load: (N/mm ²)	290

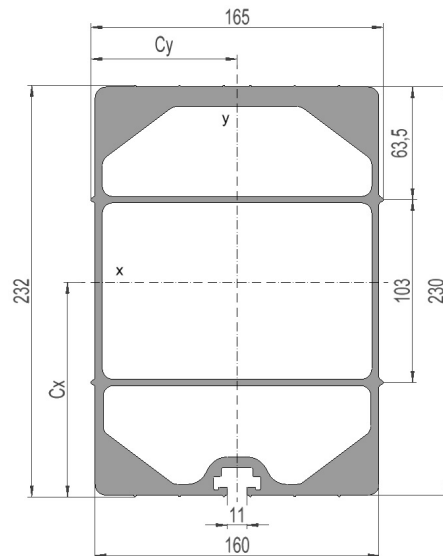

DATASHEET

2836674 - TAS5050D-50-7S

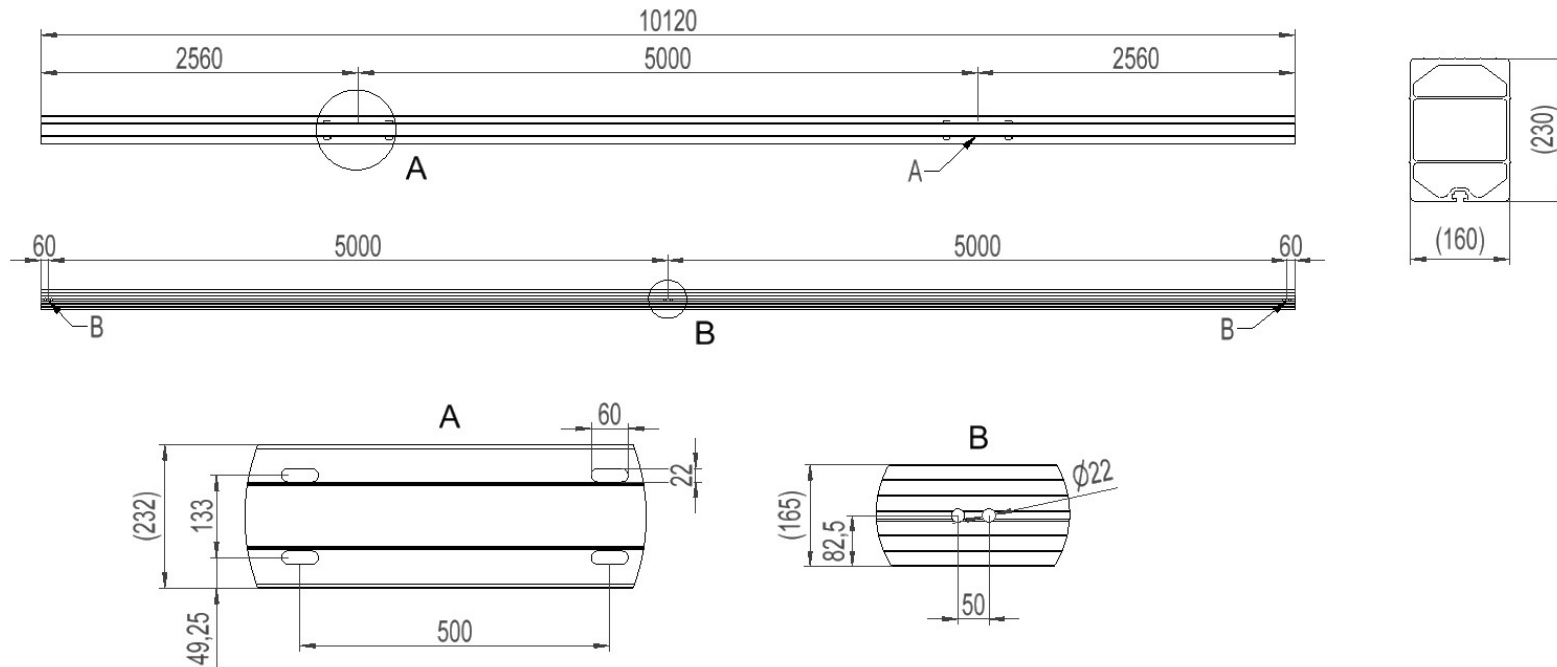

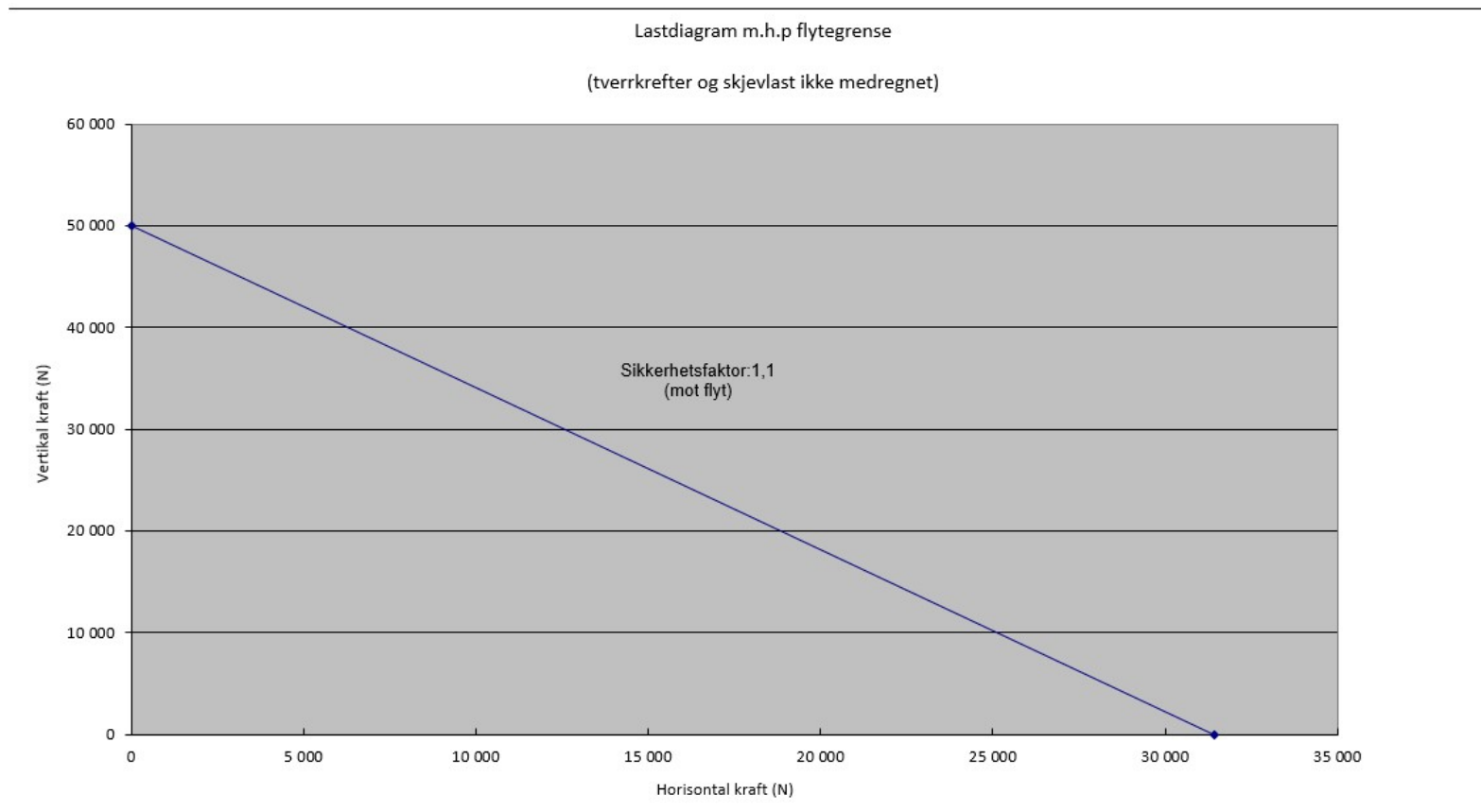

Total bøyning travers i forhold til last

