

2836678 - Avsp.trav TA5050D-34-7S

Mastetype	H/A-mast
Masteavstand	5m
Faseavstand	5m
Stolpeinnfesting	340mm-dobbel masteklave

Traversprofil P7 (liggende)

Vekt: (kg/m)	22.225
Areal: (mm ²)	8243
Materiale:	Aluminiumsprofil, bruneloksert
Legering:	AlMgSi 6082-T6
Motstandsmoment: (mm ³)	W _x = 345 747 W _y = 550 278
Annet arealmoment: (mm ⁴)	I _x = 28 524 112 I _y = 67 111 384
Senteravstand for I _x : (mm)	C _x = 82,50
Senteravstand for I _y : (mm)	C _y = 121,96
Minimum flytegrense 0,2: (N/mm ²)	250
Minimum bruddgrense: (N/mm ²)	290

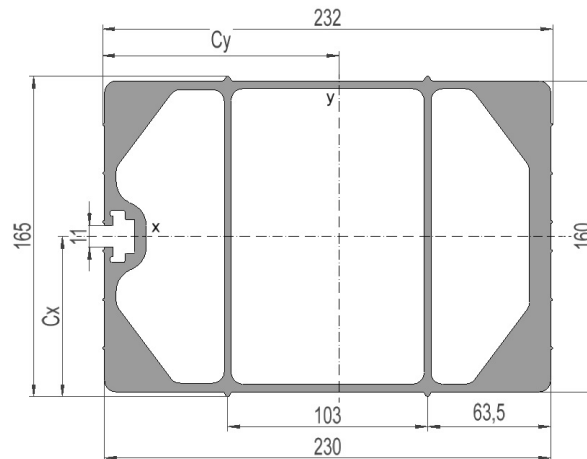

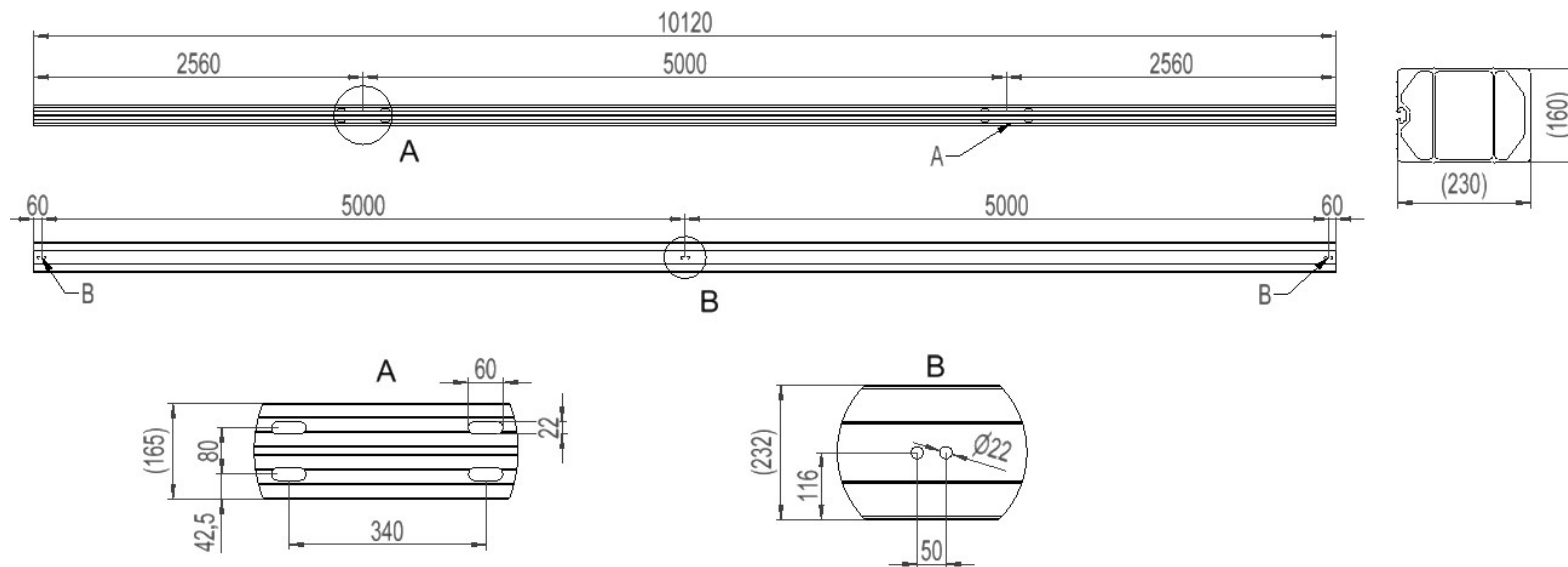

Lastdiagram m.h.p flytegrense

(Kompensert for slisshull. Tverrkrefter og skjevlast er ikke medregnet)

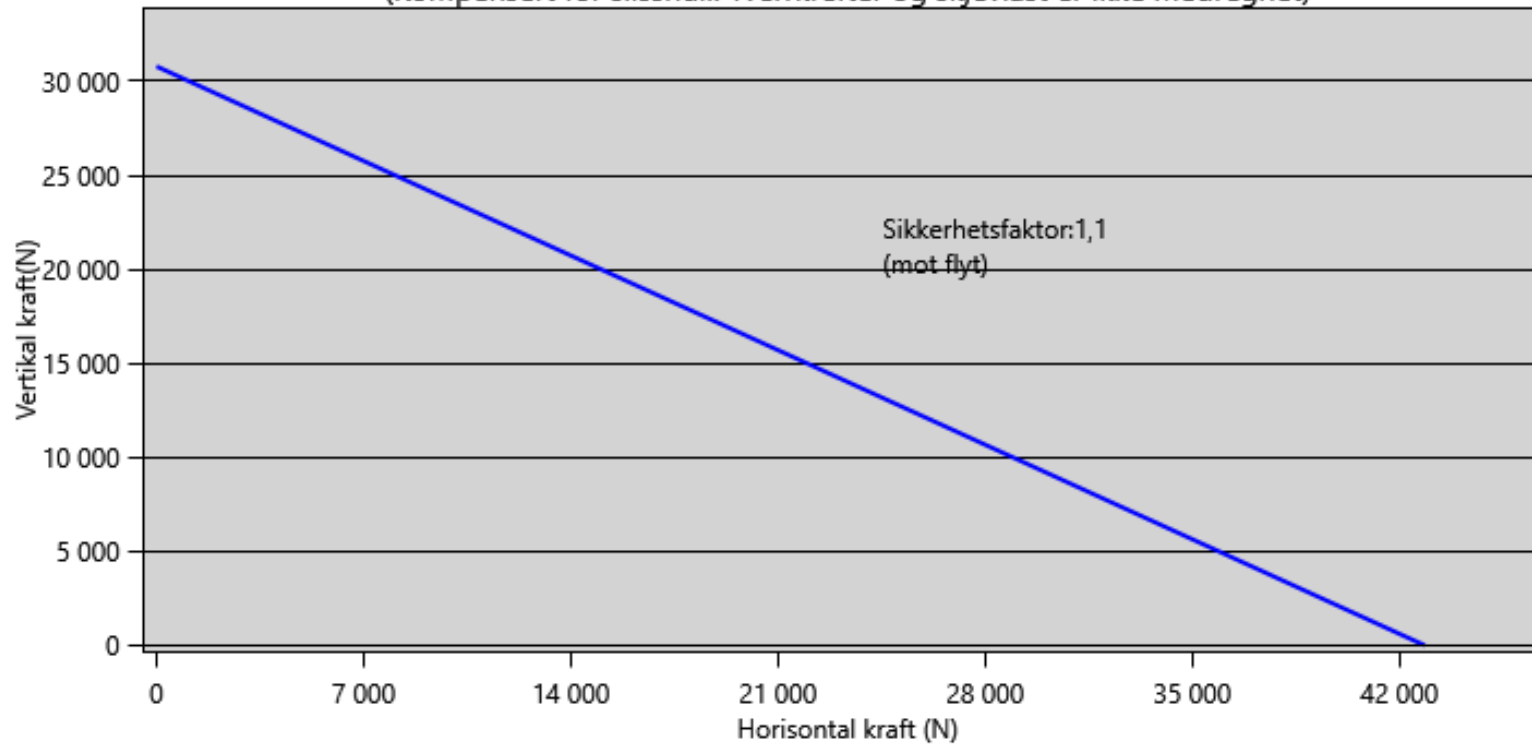

Total nedbøyning travers i forhold til last

