

2836702 - Bæretravers T33-6S

Mastetype	H/A-mast
Masteavstand	3m
Faseavstand	3m
Stolpeinnfesting	280mm-enkel masteklave

Traversprofil P6 (stående)

Vekt: (kg/m)	10.52
Areal: (mm ²)	3897
Materiale:	Aluminiumsprofil, bruneloksert
Legering:	AlMgSi 6082-T6
Motstandsmoment: (mm ³)	W _x = 233 884 W _y = 87 555
Annet arealmoment: (mm ⁴)	I _x = 28 325 925 I _y = 3 852 424
Senteravstand for I _x : (mm)	C _x = 121,11
Senteravstand for I _y : (mm)	C _y = 44,00
Minimum flytegrense 0,2: (N/mm ²)	250
Minimum bruddgrense: (N/mm ²)	290

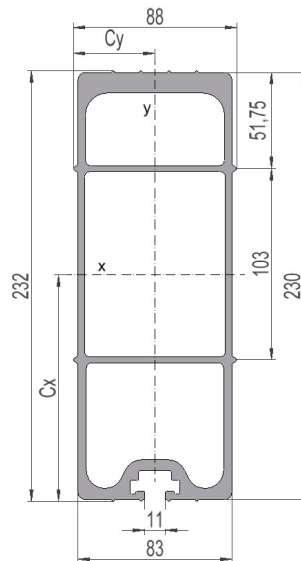

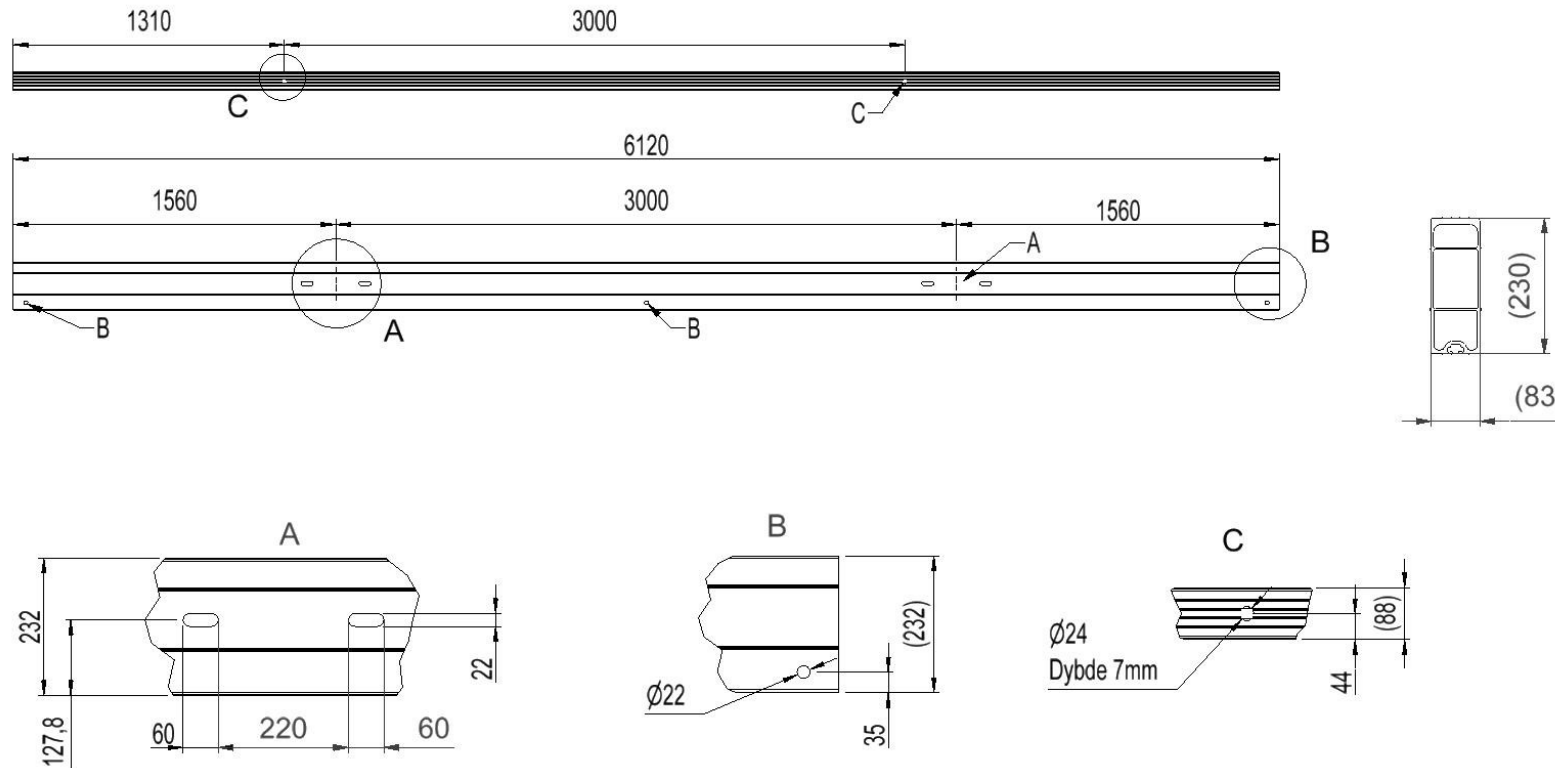

Lastdiagram m.h.p flytegrense

(Kompensert for slisshull. Tverrkrefter og skjevlast er ikke medregnet)

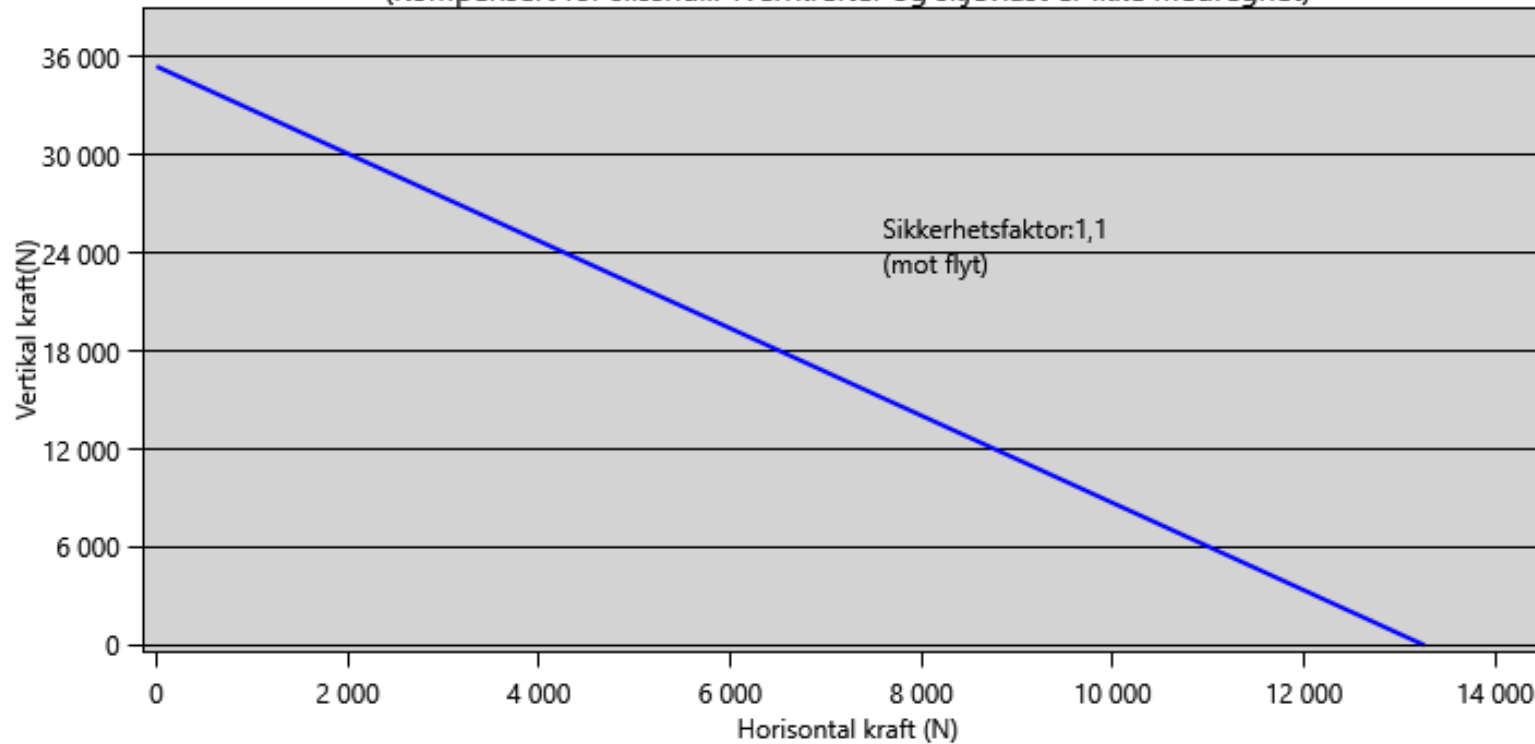

Total nedbøyning travers i forhold til last

