

## 2836755 - Phase/wire bracket FBV20

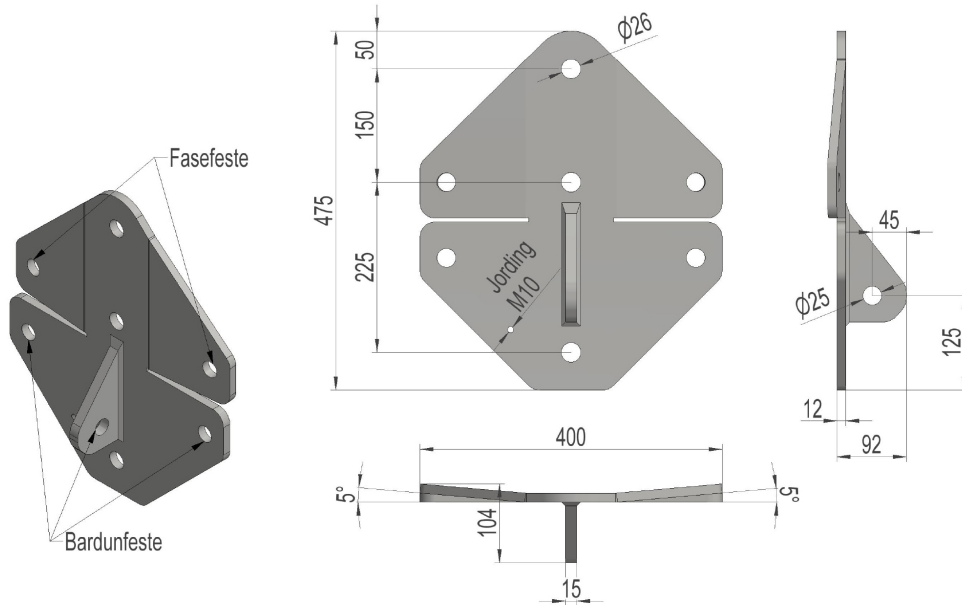

Description	Phase/wire bracket for an angle of 0-20.
Unit	PSC
Weight	13,033 kg
Material	Steel galvanised
Yield strength (static)	160kN
Breaking load (static)	200kN
Hardness	170HB