

## 2836757 - Phase/wire bracket FBV60

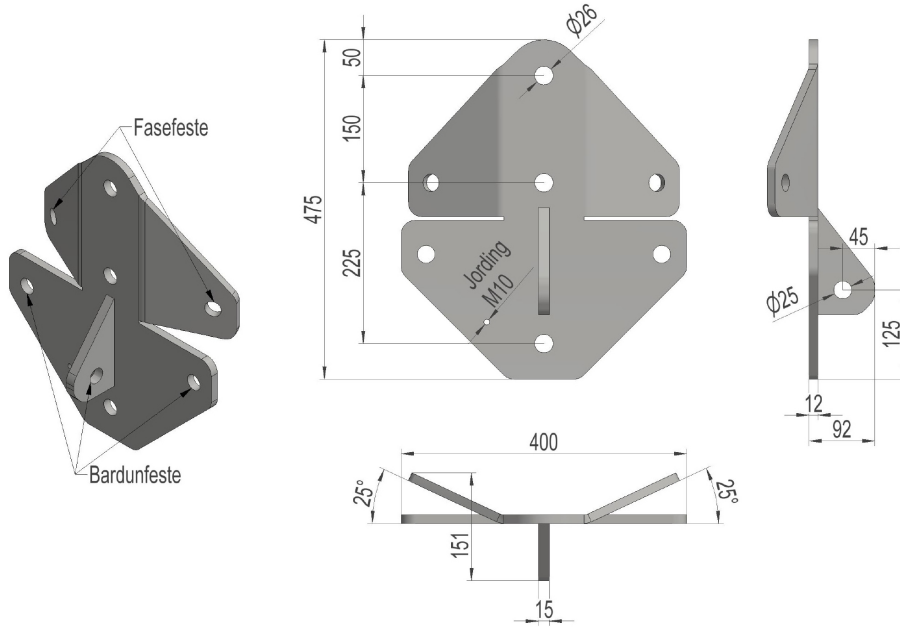

Description	Phase/wire bracket for an angle of 40-60.
Unit	PSC
Weight	13,033 kg
Material	Steel galvanised
Yield strength (static)	160kN
Breaking load (static)	200kN
Hardness	170HB