

## 2836759 - Pole clamp MK3337

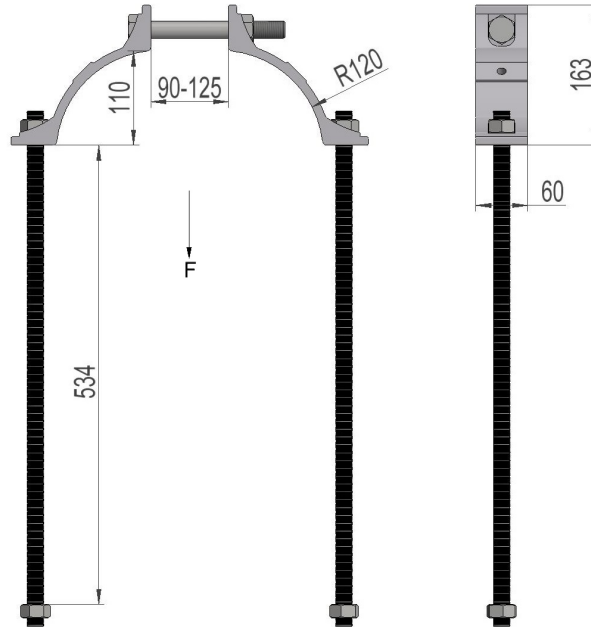

Description	Aluminium pole clamp with bolts M20x600. For pole diameter Ø300-370. Selection table with regards to crossbar type and pole diameter is on our website.
Unit	PSC
Weight	4,5 kg
Material	Aluminium, anodised-brown
Breaking load (static)	140kN