

2837422 - Top bracket TFK1-5-275

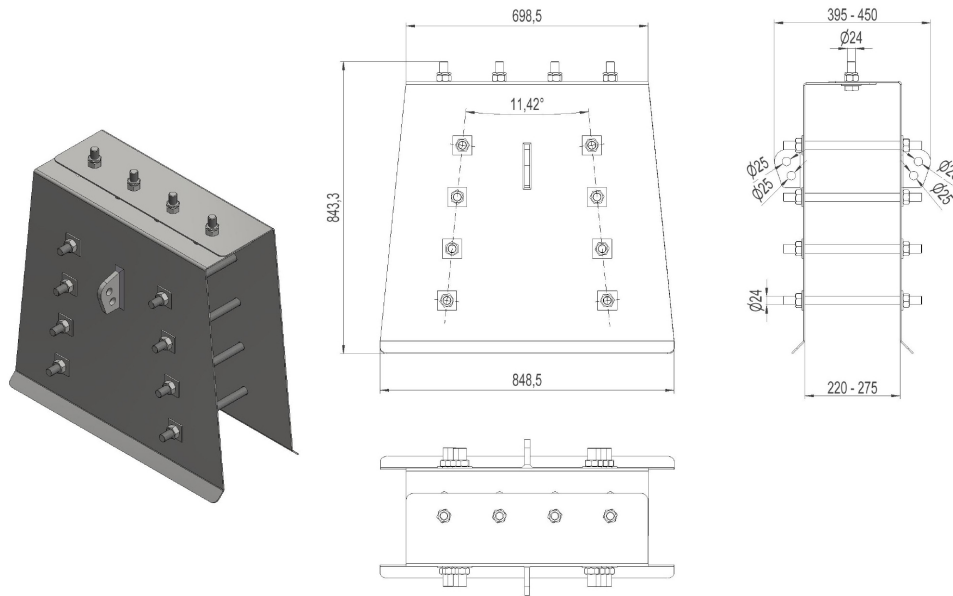

Description	Top bracket for pole Ø220-275mm (1:5). Crossbar to be mounted on top.
Unit	PSC
Weight	65 kg
Material	Steel galvanised