

2837426 - Phase/wire bracket FBV20-5B

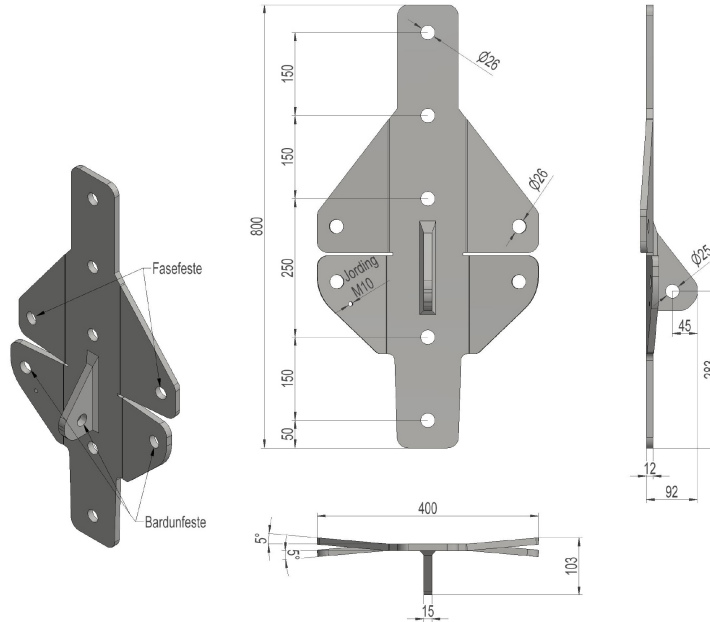

Description	Phase/wire bracket for an angle of 0-20. 5 bolts towards the pole.
Unit	PSC
Weight	18 kg
Material	Steel galvanised
Yield strength (static)	160kN
Breaking load (static)	200kN
Hardness	170HB