

2837435 - Support bracket STB107

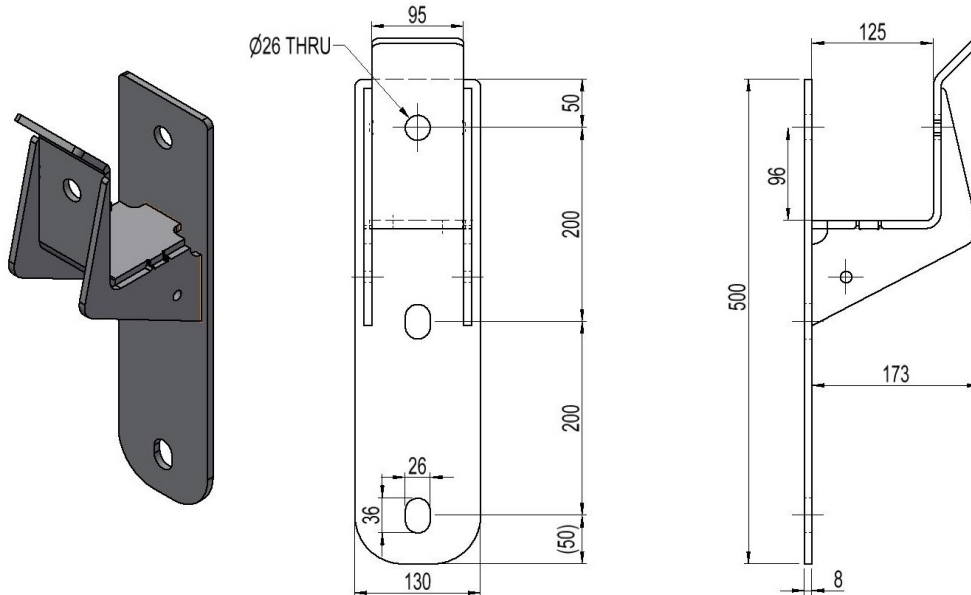

Description	Support for bolted connection. For crossbar profile 3 (width 80mm).
Unit	PSC
Weight	7,3 kg
Material	Steel galvanised
Pole fastening	Bolt