

2837439 - Load-bearing crossbar T3030-34-5S

Cross arm type	H/A-pole
Pole distance	3m
Phase distance	3m
Pole fastening	340mm-single pole clamp

Crossbar profile P5 (standing)

Weight: (kg/m)	8.653
Cross section: (mm ²)	3205
Material:	Extruded aluminum, brown anodized
Alloy:	AlMgSi 6082-T6
Moment of resistance: (mm ³)	W _x = 180 557 W _y = 55 967
Area moment of inertia: (mm ⁴)	I _x = 18 945 834 I _y = 1 958 855
Center distance for I _x : (mm)	C _x = 104,93
Center distance for I _y : (mm)	C _y = 35,00
Minimum yield strength 0,2: (N/mm ²)	250
Minimum breaking load: (N/mm ²)	290

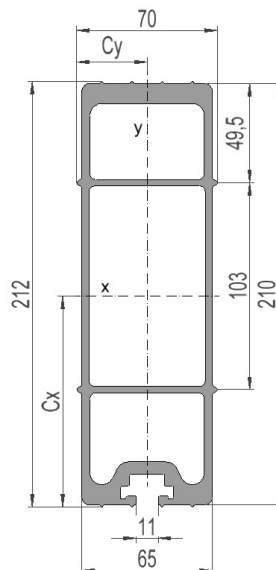

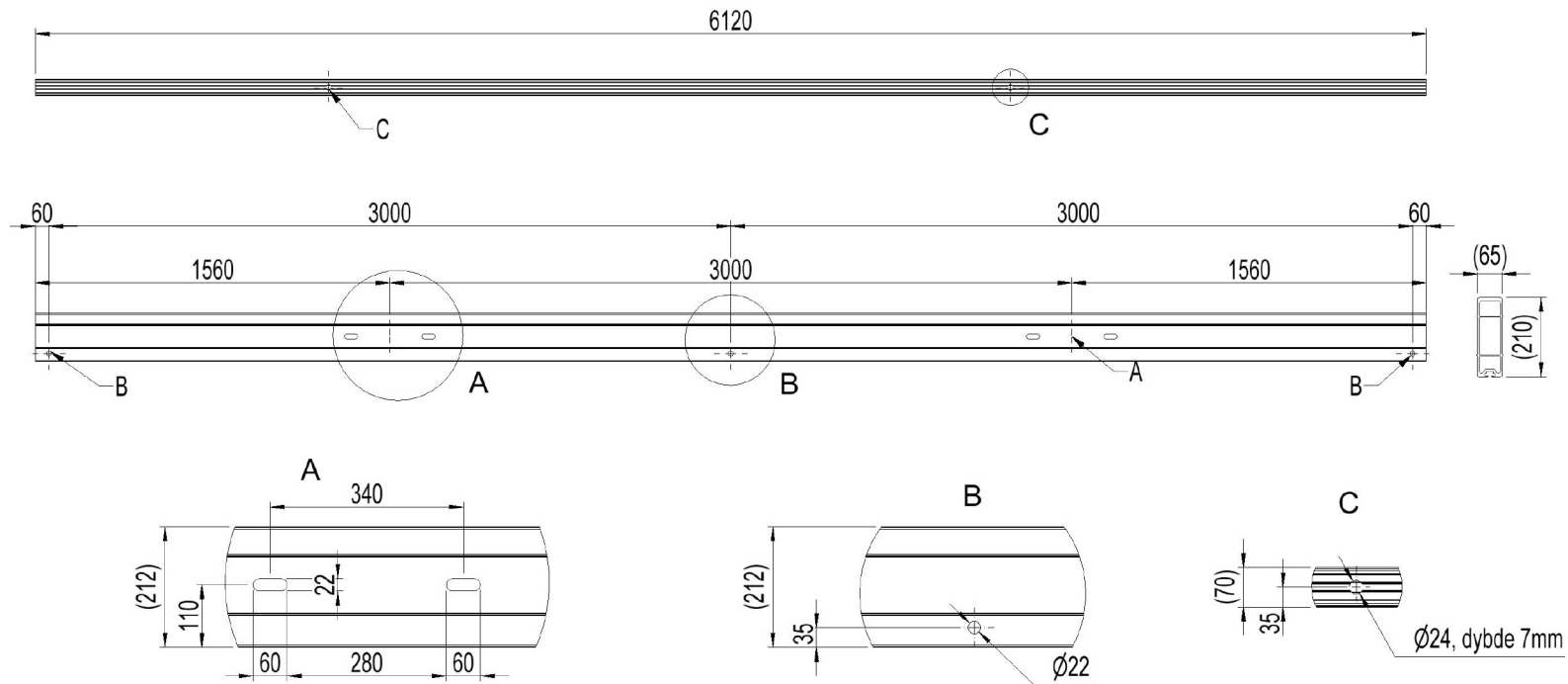

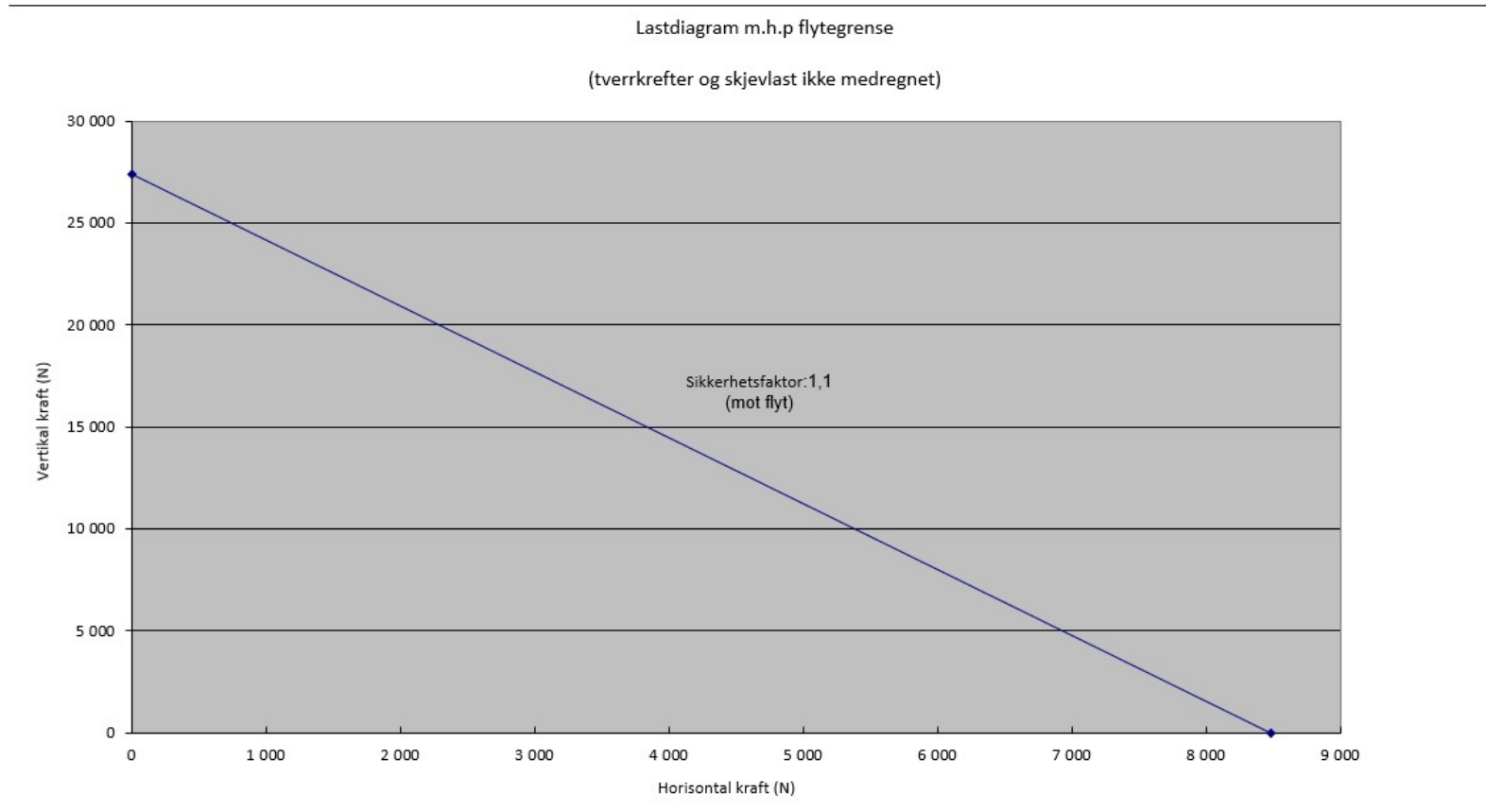

Total bøyning travers i forhold til last

