

2837441 - Pole diagonal cross STK25

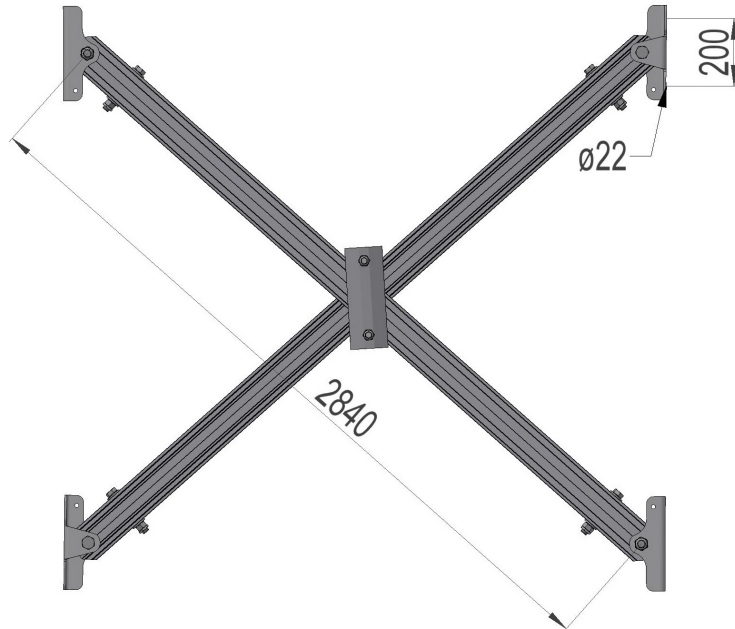

Description	Pole diagonal cross for wood and composite poles. Pole distance: 2,5m. Fixing bracket 2xØ22mm. Fasteners not included.
Unit	PSC
Weight	44 kg
Material	Aluminium, anodised-brown
Pole distance	2,5m
Crossbar profile	P1 (57,5x107)
Breaking load (static)	90kN