

2857806 - Cable clamp KSF2122

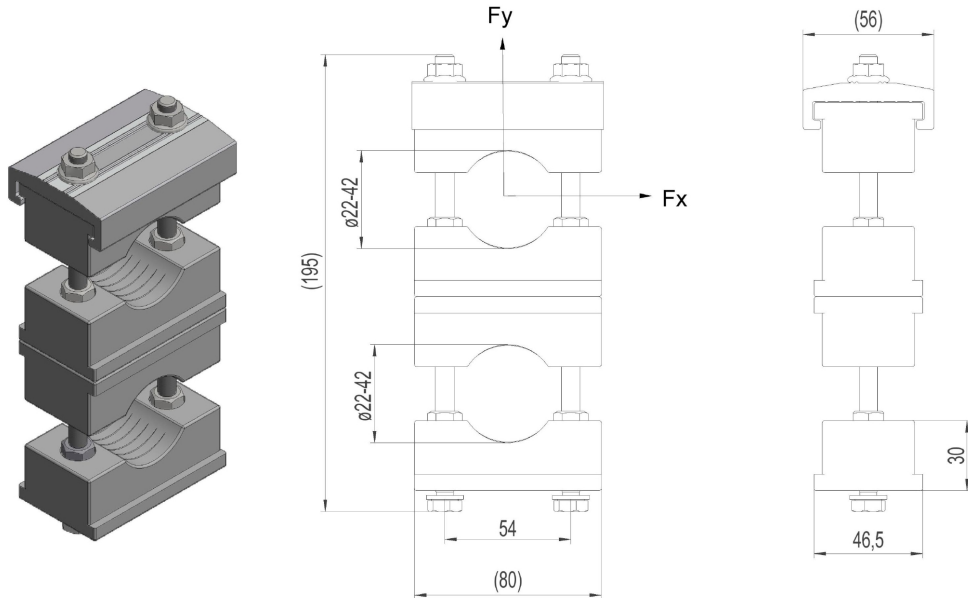

Description	Cable clamp 1-cable Ø22-42mm. Reinforced version. Delievered with fasteners M8
Unit	PSC
Weight	0,55 kg
Material	Polyethylene
Material-2	Aluminium, anodised-brown
Number of cables	2pcs
Suitable for cable diameter	Ø22-42mm
Breaking load (static)	Fy=45kN / Fx=10kN