

## 2857832 - Cable guard joint KANSB58V

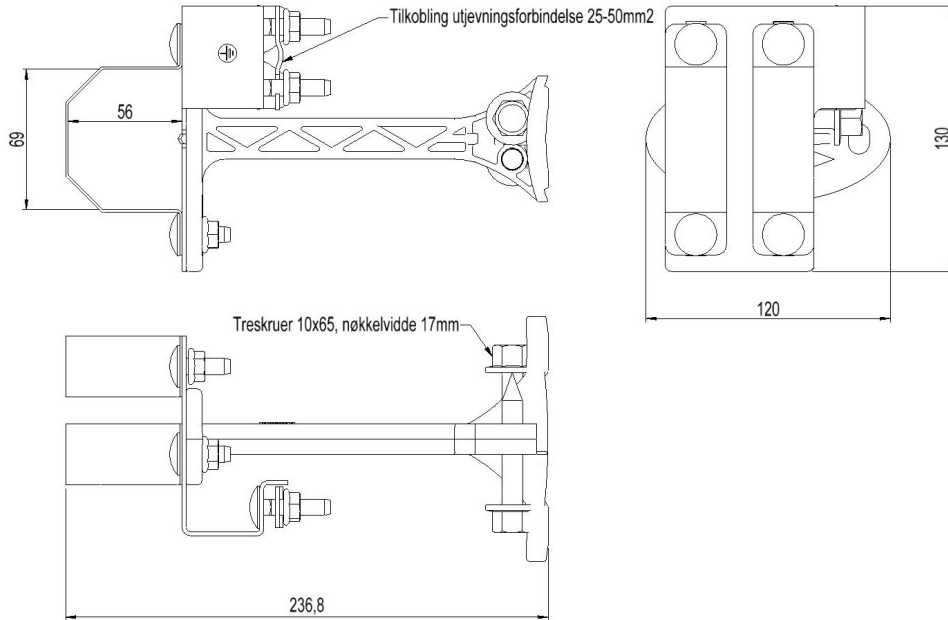

Description	Joint for galvanized cable guard Ø58mm. With connection for grounding.
Unit	PSC
Weight	0,45 kg
Material	Polyethylene
Material-2	Steel, stainless 316
Number of cables	1psc