

2857967 - Ground protection BKN1

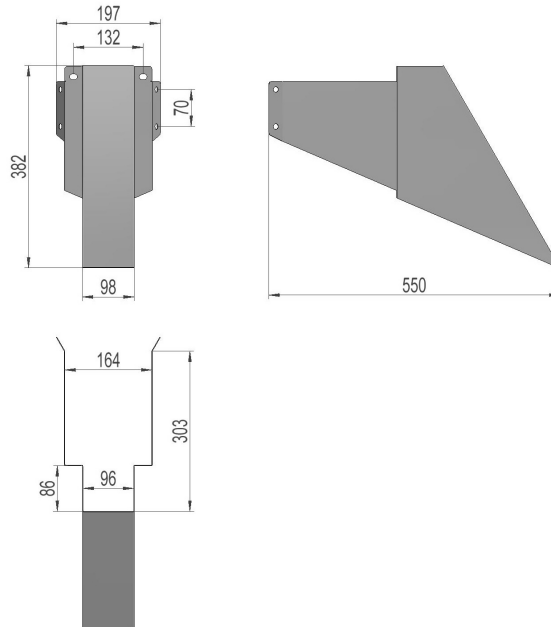

Description	Ground protection. B=96mm. Fastening screws included.
Unit	PSC
Weight	2,3 kg
Material	Steel galvanised/plastic-brown