

2859337 - Cable clamp KSF142

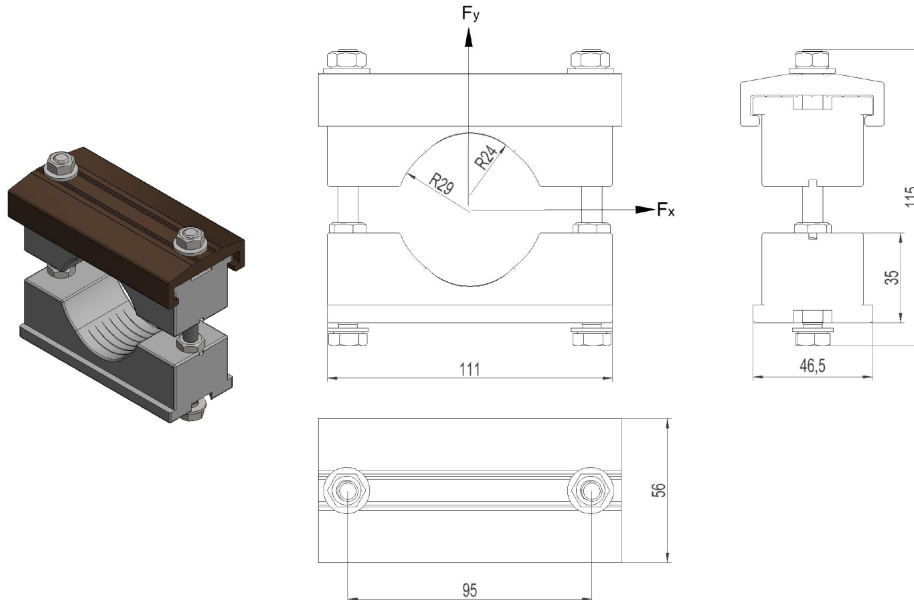

Description	Cable clamp 1-cable Ø42-60mm. Reinforced version. Delievered with fasteners.
Unit	PSC
Weight	0,4 kg
Material	Polyethylene
Material-2	Aluminium, anodised-brown
Number of cables	1psc
Suitable for cable diameter	Ø42-60mm
Breaking load (static)	Fy=45kN / Fx=10kN