

2859492 - Cable duct KN22-60

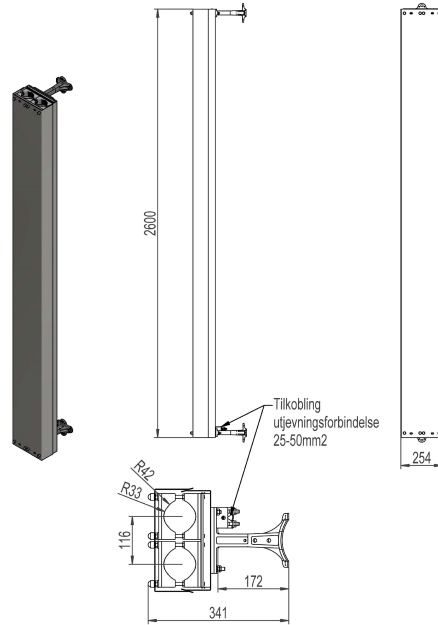

Description	Cable duct with clamps. For 2 cables \varnothing 60-84mm, length 2,6m
Unit	PSC
Weight	20,8 kg
Material	Steel galvanised/plastic-brown
Fastening method	Pole
Number of cables	2pcs
Suitable for cable diameter	\varnothing 60-84mm